

Owner's Manual

H₂ Series

**Vesta H₂, Athena H₂, and Melody II
Only from AlkaViva**



Warning: Incorrect installation and/or operation could void your valuable warranty. Please protect your investment! READ THIS MANUAL CAREFULLY.

TABLE OF CONTENTS

Congratulations on Your New Purchase	03
Important Safety Warnings and Precautions	04
Let's Take a Tour of Your H ₂ Series Ionizer.....	06
Installation Procedure	08
Operating Your Ionizer	11
Manually Adjusting the Power	13
Ionizer Performance Factors	14
Using Ionized Water	15
How To Replace the Filters	18
Using the Cleaning Filters	20
Troubleshooting Guide	21

Congratulations on Your New Purchase

Congratulations! You have just purchased the H₂ Series alkaline water ionizer and hydrogen generator. Your new H₂ Series ionizer is designed to provide you with many years of the cleanest, healthiest and most functional water available. There are many specific uses and benefits of this amazing water, so read this manual carefully to learn how to install, maintain, protect and get optimum performance out of your investment.

Your new H₂ Series Ionizer produces filtered alkaline, ionized, and hydrogen-rich water. Just exactly what is that? Your ionizer employs computer accurate and selectable magnetic energy to perform electrolysis through platinum titanium electrodes inside a water cell. Inside this advanced cell, the magnetic energy separates the water into alkaline (high pH) and acid (low pH) stream and enriches the water with dissolved molecular hydrogen (H₂) without using any chemicals. Ionizing the water also binds extra oxygen molecules, and concentrates ionized, absorbable and beneficial minerals like calcium, magnesium and potassium.

Your new H₂ series Ionizer also produces acidic water. This type of water has a low pH (less than pH 6) and has many excellent uses. You will now have the convenience and benefits of water that functions in many ways that ordinary tap, filtered or bottled water cannot.

1 Important Safety Warnings and Precautions

Electrical Precautions and Safeguards



This appliance must be grounded. In the event of a malfunction or breakdown, ground will reduce the risk of electric shock by providing a path of least resistance for electrical current. This appliance is equipped with a cord having an appliance grounding conductor and a grounding plug. The plug must be plugged into an appropriate outlet that is installed and grounded in accordance with all local codes and ordinances.



NEVER attempt to repair or service the unit yourself. Attempting to do so will void your valuable warranty! Contact AlkaViva Customer Service to arrange service or repair.



If your ionizer becomes submerged in water, unplug the power cord from the wall before removing the ionizer from the water. Failure to do so may cause electric shock!



Do not use your ionizer at voltages other than specified (AC 110-120V). Use a grounded outlet. Do not plug in your ionizer where it will exceed the rating of the outlet or electrical wiring. Failure to do so can result in fire, injury and/or damage to your wiring, your ionizer, or yourself!



NEVER touch the power cord or plug with wet hands - this may result in electric shock!



Do not wash your ionizer by immersion or by pouring water over the main body; always unplug your ionizer while cleaning the casing. Clean with damp sponge or cloth.



Ensure the power plug is firmly and properly inserted into the outlet - failure to do so may result in electric shock or fire!



Keep the power cord and your ionizer away from hot surfaces or appliances - failure to do so may result in electric shock or fire!



Do not operate your ionizer with a damaged power cord or plug or insert into a faulty or worn outlet.



Never insert foreign objects into your ionizer.



Always unplug your ionizer when changing a fuse or cleaning your ionizer. Failure to do so may result in an electric shock!

2 Let's Take A Tour of Your NEW H₂ Series Ionizer!

Front View



Rear View

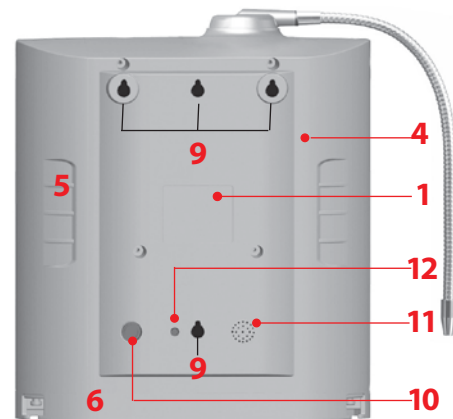

Bottom View

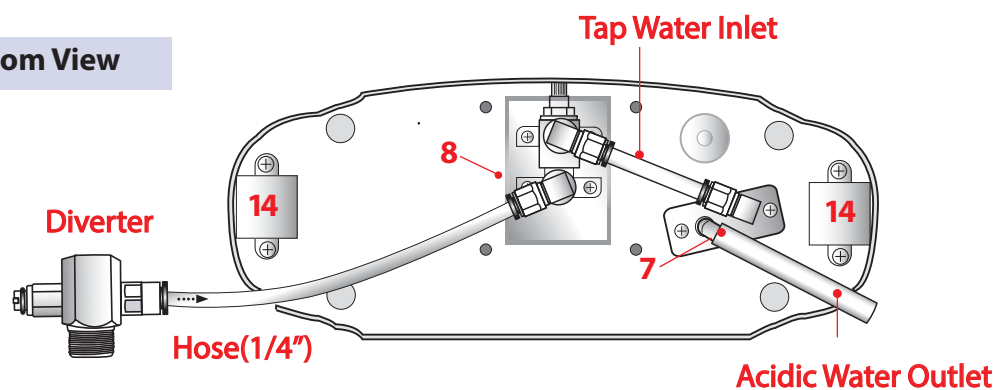

#	Name	Description
1	Back Panel	Covers the back of the ionizer.
2	Control Panel	Function controls and display. Detailed on next page.
3	Flexible Stainless Steel Spout	Outlet for either alkaline or acidic water (user-selected).
4	Front Panel	Covers the front of the ionizer.
5	Filter Cover	Remove this panel to change filters.
6	Bottom Panel	Covers bottom of the ionizer.
7	Acidic Water Outlet	For acidic water. Labeled with red sticker.
8	Water Inlet	Tap water supply. Labeled with black sticker.
9	Key-hole Slots	For wall mounting.
10	Fuse Holder	Fuse.
11	Audio Speaker	Transmits voice and melody.
12	Audio Volume Control	Volume control.
13	Flow Control Valve	On/Off and water flow adjustment.
14	Locking Device	Filter cover safety lock. Depress when removing filter cover.

Control Panel

Acidic Water Indicator
 Illuminates when acidic water is selected.

Filtered Water Indicator
 Illuminates when filtered water is selected.

Alkaline Water Indicator
 Illuminates when alkaline water is selected.

Water Flow Indicator
High
 H range illuminates to indicate maximal flow. (Lower performance.)
Normal
 Normal range illuminates to indicate optimal flow. (Normal performance.)
Low
 L range illuminates to indicate low flow. (Best performance - water may taste unpalatable.)

Filter Life Indicator
 1st and 2nd filter indication.

Error Code Indicator
 Shows error codes for trouble shooting with AlkaViva Customer Service.

Filtered Water Selection Button
 Select Filtered Water only.

Alkaline Water Selection Buttons
 Select Alkaline Water. (Alkaline 1,2,3,4 and Alkaline 5)

Acidic Water Selection Buttons
 Select Acidic Water. (Acidic 1, Acidic 2)

H₂ WATER IONIZER

OPEN CLOSE

3 Installation Procedure



Installation Precautions



Protect your ionizer from freezing temperatures.



Do not put anything heavy on top of your ionizer.



Protect your ionizer from direct sunlight.



Do not install your ionizer on an unstable or soft surface.



Install only on a hard and level surface.



Do not install close to a stove.



Install close to a properly grounded electrical outlet.



Do not close, bend, pinch, press or otherwise obstruct hoses.

If you have installation questions, please call AlkaViva Customer Service.

Installation Options

Install Method 1: At your sink attached to your faucet with the diverter,

Install Method 2: At your sink but plumbed directly to your cold water line (no diverter) and,

Install Method 3: Under-sink - completely out of sight with a small dedicated faucet.

It is recommended that Methods 2 and 3 be done by a plumber.

Make Sure You Have All the Accessories

Before installation, please check to ensure you have the accessories pictured below.

Please note that the diverter and adapters accommodate the vast majority of standard faucets. The angle-stop adapter fits both 1/2" and 3/8" standard plumbing. If you have a non-standard or a custom faucet, or plumbing, you may need to locate and purchase additional parts. If you need help, please contact AlkaViva Customer Service.



Complete Installation Package



Angle Stop Adapter



pH Test Reagent



In-line Sediment Filter



Calcium & Scale Guard Inserts - 1 of each

NOTE The sediment filter is an optional accessory that will further protect your ionizer and lengthen the life of your filters. It is installed in the 1/4" white tap water inlet hose before it enters your ionizer in any of the three installation methods. It can be opened and cleaned as needed.

Install Method 1: At the sink with a diverter (easiest)



Tools You May Need:

- Standard pliers or channel locks
- A sharp knife or a good pair of kitchen scissors



3. ATTACH THE GRAY ACIDIC WATER OUTLET HOSE (Fig. 2) - Attach the gray hose to the white plastic port labeled **ACIDIC WATER OUTLET** on the bottom of the ionizer. First, slide a squeeze clamp over the end of the hose. Attach the gray hose by simply pushing it firmly over the white plastic port. Soaking it in hot water for 30 seconds will make attaching it very easy. Squeeze the clamp and position it over the white port. Ensure the opposite end runs into the sink.

4. POSITION YOUR IONIZER - Ensure it is on a hard and level surface. See installation precautions.



Attach 1/4" White Hose to Diverter Fig. 3



1. ATTACH DIVERTER TO YOUR TAP - Remove the aerator from tap (pliers may be required) and attach diverter valve in its place. There are adapters supplied in case the diverter does not fit your tap. If you have leaks at the diverter, use plumber's Teflon tape (included).

2. ATTACH THE 1/4" WHITE TAP WATER INLET HOSE (Fig. 1) - Attach the white 1/4" hose to the white port on the bottom of the ionizer labeled **TAP WATER INLET**. To attach the white hose, simply push it firmly into the opening on white port. Give it a gentle tug to ensure proper connection. If it is properly installed, it will not come out. If you need to remove it, press on the ring at the end of the fitting while pulling out.

5. ATTACH THE 1/4" WHITE HOSE TO THE DIVERTER (Fig. 3) - Measure the appropriate length of white hose, allowing for a reasonable amount of slack, and cut using sharp knife or scissors. Remove the small compression nut on the back of the diverter (opposite of the lever). Slide the nut over the opposite (free) end of the white 1/4" hose with the threads positioned so it will screw onto the diverter. Push the hose firmly onto the nipple, then screw the compression nut back on. Ensure the nut is tightened firmly. Do not over tighten.

6. CONNECT THE POWER CORD - Use an appropriate grounded outlet.

7. INSTALL FLEXIBLE STAINLESS STEEL SPOUT - Screw the spout clockwise into the threaded silver port on top of the ionizer. Do not over tighten.

8. SAVE THE BOX your ionizer came packed in. This will help if your ionizer needs to be transported at a later date.

Install Method 2. At the sink, direct plumb (more difficult/convenient/attractive)



Tools You May Need:

- Wrench
- Pliers
- Drill with 1/4" or 5/16" bit

1. INSTALL ANGLE STOP ADAPTER (included) to COLD WATER SUPPLY LINE

Locate the cold water line. Shut off the cold water supply. Unscrew the flexible supply line from the angle stop. Attach the adapter. (Fits standard 1/2 and 3/8" plumbing.) Make sure adapter is in "open" position (blue knob parallel to the length of the body of the adapter). Leave angle stop closed. (water shut off) (Fig 1)



Attach 1/4" white hose to angle stop adapter

Fig. 1

2. ATTACH THE WHITE 1/4" TAP WATER INLET HOSE TO THE ANGLE STOP ADAPTER (Fig. 1)

Attach the white 1/4" hose to the adapter by simply pushing firmly into the white port. Give a gentle tug to ensure proper connection. It should not come out. You will need a way to route the white hose from the adapter to your ionizer. Most newer sinks have cutouts that will work for this. If not, drill a 1/4" hole.

3. ATTACH THE WHITE 1/4" TAP WATER INLET HOSE TO YOUR IONIZER (Fig. 2)

Attach opposite (free end) of the white 1/4" hose to the white **TAP WATER INLET** port on the bottom of the ionizer. To attach the white hose, simply push it firmly into the **TAP WATER INLET** port. Give it a gentle tug to ensure proper connection. It should not come out. To remove it, press on the end of the fitting and pull it out at the same time.



1/4" White Hose to Tap Water Inlet Port Fig. 2

4. ATTACH THE GRAY ACIDIC WATER OUTLET HOSE (Fig. 3) - Attach the gray hose to the white plastic port labeled **ACIDIC WATER OUTLET** on the bottom of the ionizer. First, slide a squeeze clamp over the end of the hose. Attach the gray hose by simply pushing it firmly over the white plastic port. Soaking it in hot water for 30 seconds will make attaching it very easy. Squeeze the clamp and position it over the white port. Ensure the opposite end runs into the sink.



Gray Hose To Acidic Water Outlet Port Fig. 3

5. POSITION YOUR IONIZER - Ensure it is on a hard and level surface. See installation precautions.

6. CONNECT THE POWER CORD - Use an appropriate grounded outlet.

7. INSTALL FLEXIBLE STAINLESS STEEL SPOUT - Screw the spout clockwise into the threaded silver port on top of the ionizer. Do not over tighten.

8. SAVE THE BOX your ionizer came packed in. This will help if your ionizer needs to be transported at a later date.

Install Method 3. Under-sink with conversion kit (most difficult)

Under-sink installations can only be accomplished with an AlkaViva Under-sink Conversion kit. Off the shelf parts will not work. Your ionizer will require a very specialized faucet and a variety of other parts. The Conversion Kit comes with everything needed including instructions to complete this type of installation. It is recommended that a plumber perform this type of installation. Please contact AlkaViva Customer Service for details.

4 Operating Your Ionizer

Operating Precautions



Do not run hot water through your ionizer. Doing so will damage your filters.



Do not clean by spraying or pouring water over the ionizer. Clean using warm soapy water and a sponge or clean rag.



Do not use benzene, paint thinner or insecticidal sprays for cleaning your ionizer. Doing so can damage the finish.



Do not close, bend, pinch, press or otherwise obstruct output ports or hoses.



If the appliance makes strange or unusual noises or odors are detected, unplug the power cord immediately and contact AlkaViva Customer Service to arrange service.



Unplug your ionizer if you plan not to use it for an extended period. Filter replacement may be necessary when you use it again. Store your filter in a plastic bag inside of your refrigerator to prevent bacterial growth.



Your ionizer is not under warranty for any damage caused by hard water.



Do not use an ionizer downstream of any ion exchange water softening system or reverse osmosis system without first consulting AlkaViva Customer Service.



Make sure to use your ionizer only with potable water which is suitable for human consumption.



DO NOT use your ionizer with well water, water with extreme hardness, high sediment or TDS levels without first contacting AlkaViva Customer Service.

1. Start the Water Flow Through Your Ionizer

For Installation Method #1 - at the sink with a diverter:

1. OPEN THE FLOW CONTROL VALVE - This control is on the front of the machine and has an **ON** and **OFF** position. Try initially setting this half way between **ON** and **OFF**

Important : This is one of the most critical features in controlling your ionizer's performance. This control **WILL DIRECTLY** impact the performance of your ionizer. **A slow flow will yield higher performance; a fast flow will yield lower performance.**

2. TURN ON YOUR COLD WATER FAUCET - Turn the diverter lever until the water runs through your ionizer.

3. NOTICE THE DIFFERENCE IN FLOW RATES by adjusting the **FLOW CONTROL VALVE** from a slow trickle to the fastest flow. When you begin hydrogen-infused ionized water, start with it in the normal range for optimal results.



For Installation Method #2 - at the sink direct plumbed

1. TURN ON YOUR WATER SUPPLY LINE AT THE ANGLE STOP - Ensure the angle stop adapter is in the open position. (The blue knob parallel to the length of the adapter body.)

2. OPEN THE FLOW CONTROL VALVE - This control is on the front of machine and has an **ON** and **OFF** position. When ionizing water initially try opening the valve half way between **ON** and **OFF**.

Important : This is one of the most critical features in controlling your ionizer's performance. This control **WILL DIRECTLY** impact the performance of your ionizer. **A slow flow will yield higher performance; a fast flow will yield lower performance.**

3. NOTICE THE DIFFERENCE IN FLOW RATES by adjusting **FLOW CONTROL VALVE** from a slow trickle to the fastest flow. When you begin making hydrogen-infused ionized water, start with it in the normal range for optimal results.

WHAT YOU WILL NOTICE:

- The control panel will illuminate, and water should flow from both hoses.
- The Digital Filter Life Indicator will begin to register numbers and you will hear your ionizer's "voice" announcing the mode of operation. For instance: "Purified water selected".

NOTE: The water will initially come out discolored (light to charcoal gray) due to carbon dust in the new filter. This is not harmful and is typical of all carbon filters. Allow the water to flow for 1-2 minutes in the **PURIFIED** mode until it runs clear.

2. Selecting Alkaline Ionized Hydrogen-Infused Water

Control Panel



Water Flow Indicator



When the tap water flows through your H₂ Series Ionizer, the Water Flow Indicator illuminates: **L** when the water pressure/flow rate is low and **H** when it is high, **NORMAL** when it is normal. Your H₂ Series Ionizer will produce optimal performance for drinking water (the perfect balance in pH, -ORP, H₂ and taste) when it is in the normal range.

When you select Alkaline water, it will flow through the Flexible Stainless Spout at the top of your H₂ Series Ionizer.

1. Open the Flow Control Valve to let the water flow in. Your control panel will illuminate and the word **ALKALINE** will show on the display. For optimal performance, set the value so the flow is in the normal range on the display.
2. Use the **ALK** button to select the level. The level you have selected will illuminate next to the **ALK** button and a numerical approximation of the pH level will appear on the display.
3. You will hear voice confirmation: "Alkaline Ionized Water on process."
4. To change alkaline levels, simply depress the button of the alkaline level desired, **ALK 1-5**. **ALK 1** is the weakest setting and **ALK 5** is the strongest.
5. Your H₂ Series Ionizer will always "remember" the last setting used. If you were using **ALK 2**, the next time you start your ionizer it will automatically start on **ALK 2**.

Exception to the above: when **ALK 5** (strong alkaline) is selected, your H₂ Series Ionizer will come on at the last **ALK 1-4** level used the next time you use it.

Alkaline Level Buttons



What You Will See In the Display



This number will change depending on the **ALK** setting you have chosen.

3. Selecting Acidic Ionized Water

Acidic Level Buttons



What You Will See In the Display



This number will change depending on the **ACID** setting you have chosen.

When you select Acidic water, it will flow through the Flexible Stainless Spout at the top of your H₂ Series Ionizer.

1. Open the Flow Control Valve to let the water flow in. Your Control Panel will illuminate.
2. Use the **ACID** button to select the level. Your control panel will illuminate and the word **ACID** will show on the display. For optimal performance, set the value so the flow is in the normal range on the display.
3. You will hear voice confirmation: "Acidic Ionized Water on process." You will also hear a melody to alert you that acidic water is running.
4. To change acid levels, simply depress the button of the acidic level desired, **ACID 1** or **2**. **ACID 1** is the weakest setting and **ACID 2** is the strongest.
5. Your H₂ Series Ionizer will always "remember" the last alkaline setting used. If you were using **ACID 1**, the next time you start your ionizer it will revert to the last **ALK 1-4** level you used.
6. When the tap water flows through your H₂ Series Ionizer, the Water Flow Indicator illuminates: **L** when the water pressure is low and **H** when it is high, **NORMAL** when it is normal.

NOTE:

- Acidic ionized water is not intended for regular drinking water. Acidic ionized water has many great uses. Learn more about this in the next section on using acidic water.
- The DARC cleaning system will help keep your electrodes clean. Running acidic water through your ionizer will keep the rest of the components of the machine clean. If you live in a hard water area this should be done daily for 1-2 minutes.

4. Selecting Purified Water

Purified Water Buttons



Purified water is only filtered, not ionized. When selected, it will flow through the Flexible Stainless Spout at the top of your H₂ Series Ionizer.

What You Will See In the Display



PU will always appear.

1. Open the Flow Control Valve to let the water flow in. NOTE: Your control panel will illuminate.
2. Use the **PURIFIED** button to select filtered water. On the control panel the word **PURIFY** will illuminate and the letters "PU" will illuminate on the display panel.
3. You will hear voice confirmation: "Crystal clear water in production."
4. Your H₂ Series Ionizer will always "remember" the last alkaline setting used. If you were using **PURIFIED**, the next time you start your ionizer it will revert to the last **ALK 1-4** level you used.

When the tap water flows through your H₂ Series Ionizer the Water Flow Indicator illuminates: **L** when the water pressure is low and **H** when it is high, **NORMAL** when it is normal.

5 Manually Adjusting the Power

While AutoAdjust automatically provides very fine real-time adjustments to the pulse width, you can also manually adjust the power to best suit your unique water quality and desired performance requirements. By manually changing the power-steps for each Alkaline and Acidic level, you can change the main power settings, making bigger and more impactful changes in performance. Here's how:

Step 1. Start water flow through your ionizer by turning on the Flow Control valve and/or Diverter.

Step 2. For this example, we will use **ALK 5** level. You may manually set this for each **ALK** or **ACID** level. Select the **ALK** or **ACID** level you'd like to adjust – just as you would for changing levels under normal operation.

Step 3. Press and hold the **ALK 5** button until Display changes and looks like this:



The first digit (5) means "ALK Level 5" and second digit (3) means electric power value 3. There are four electric power values available;

Power Level 1 is the lowest and Power Level 4 the highest. If you want to raise or lower the Power Value, press same button (ALK Level 5). The second digit will change to reflect the power level.

Step 4. Press "purify" to set the value. The next time you use the ionizer, it will "remember" the last manually selected Power Level. You must set each **ALK** and **ACID** level.

Step 5. For other levels, please repeat the steps above.

6 Ionizer Performance Factors

Very Important Information About Your Ionizer Performance

There are three primary factors that control the performance of your ionizer:

- 1) The quality of your source water and its mineral content. We cannot control this factor.
- 2) The voltage being applied to the water. You control this by selecting the **ALK** level or **ACID** level on the control panel. The higher the setting, the more voltage or power applied to the water.
- 3) The flow rate of water through your ionizer. You control this with the Flow Control knob on the control panel. This determines how long the water is being processed. With a fast flow your ionizer will produce lower pH, with a slow flow it will produce higher pH.

Water quality and mineral content vary greatly in different localities. Use the pH Test Kit and be sure to test your source water.

Generally in "hard water" areas where mineral content is higher, your ionizer will easily reach high levels of pH even with a faster flow. In "soft water" areas where mineral content is lower, your ionizer may only reach the higher levels of pH with a slower flow. If your source water tests at a very low pH, you may want to "boost" performance by adding a calcium cartridge into the calcium port at the top of the ionizer filter (see the next section).

How to Measure pH

1. Fill a shot glass or other small, clean glass container with about 1 inch of alkaline, acidic or purified water.
2. Place 3 drops of the pH reagent into the vessel and gently shake or stir. If the reagent and water are not mixed well, the correct result may not be achieved. Too many or too few drops will affect results.
3. The pH value is determined by matching the color to the pH color chart provided.
4. Keep the pH reagent in a dark and cool place. DO NOT expose to sunlight or heat.
5. Be sure to rinse out the vessel thoroughly prior to each use or the pH level may be incorrect.
6. Do not drink the water that has been tested with the pH testing solution.

7 Using Ionized Water



Caution

Don't Develop a "Drinking" Problem!

If you have never consumed hydrogen-infused ionized water, do not use a setting higher than 1 to begin with. Let your body adjust slowly and naturally for 2-3 days. After this initial adjustment period, gradually increase the alkalinity of the water by increasing the setting you use.

Do not take medications with hydrogen-infused ionized water. Take medications only with purified water.

Consult with a physician before drinking hydrogen-infused ionized water if you are currently under medical treatment, have a chronic disease, or have achlorhydria.

Consult a physician before using acidic water externally if you have sensitive skin or allergies. Do not drink acidic water.

Only use potable drinking water in your ionizer. Poor water quality may have negative effects on your health and your ionizer! Most municipal water sources will be fine in your ionizer. Well water and water from smaller systems should be checked and may require pre-filtering.

Do not drink the following types of water:

- Acidic water.
- Water drained after self cleaning.
- Water tested with the pH reagent.

Additional Cautions

- Do not use the water in an aquarium.
- Ionized water loses its effectiveness if stored for more than a day or two.

NOTE Ionized hydrogen-infused water is always best fresh out of the machine and ideal if consumed on a day-to-day basis. Carry it with you in glass, ceramic or high quality BPA-free plastic bottles. Always keep your stored water cool and away from direct sunlight to preserve optimal water quality.

Other Uses for Hydrogen-infused Alkaline Ionized Water (in addition to drinking)

Cooking rice

Try cooking rice after soaking the rice in the alkaline water for 30 ~ 60 minutes in advance. When cooking rice with the alkaline water, the rice will be glossy, tasty, and it will store better for a longer period of time.



Coffee, black tea and herbal tea

Help remove the bitter taste of coffee and the puckery taste of black tea as well as enriching the faint taste and fragrance unique to black tea.



Heavy drinking and hangover

If you drink a 12-16 oz glass before going to bed or on an empty stomach in the morning you will minimize the effect of a hangover.

Various dishes

When cooking bamboo shoots, tree shoots, taro and seaweed with the alkaline water, the bitter taste and the sour taste will be gone while the natural taste will be enriched. When using it as the water for steaming fish, the fishy smell will be eliminated and it will make the fish taste better.

Liquors and cocktails

When used as the water for mixing, liquor will taste softer and milder. Ditto when making a cocktail using ice made from alkaline water.



Plants

If seeds are soaked in the alkaline water before being planted, the germination rate will be enhanced. In case of stem cutting or grafting, they will take better.

Vegetables and fruits

Wash vegetables or fruits in alkaline water and they can be kept fresh for a longer period of time.

Vegetables with unpleasant odors

When cooked after being soaked in the alkaline water for about 20~30 minutes, odor will be reduced, making vegetables softer and tastier.



Using Acidic Water

Skin Care

Acidic water can be a beauty solution good for your skin. It acts as an astringent and helps make the skin soft and elastic. (Skin is mildly acidic.)

Hair Care

Use acidic water as a hair rinse after shampooing to neutralize the alkalinity of the shampoo, and help retain the hair's natural gloss.

Shaving

Use acidic water after shaving; it can replace skin toner or after shave.

Floral arrangement

Use acidic water for cut flowers. It will keep the flowers fresh for a longer period of time.

Boiling eggs

When the acidic ionized water is used for boiling eggs, the shell is less likely to crack while cooking and the eggs will peel easily.

Water for parboiling noodles

When the acidic ionized water is used for parboiling noodles, it will make them chewy and tastier.

Washing or processing deep colored fruits and vegetables

Washing peaches, grapes, strawberries, red cabbages, beans and asparagus etc. with acidic water will retain their natural colors and they will stay bright and vibrant.

When preparing fried dishes

Use acidic ionized water to prepare batter for fried dishes to make the foods crispy and tastier.

General cleaning

When the acidic ionized water is used for cleaning floors, dirt and grime can be easily removed and it dries quickly.

Cleaning glass

When glass, mirrors and glasses are washed with acidic ionized water, dirt and grime is easily removed and glass is shiny without streaks.

Encrusted pots and pans

Soak pots and pans in the acidic ionized water overnight to remove encrusted or burnt food.

Cleaning the cutting board or counters

Use acidic ionized water to naturally clean and sanitize your cutting board and counters.

Cleaning dishes and silverware

Use it for cleaning dishes and silverware. It will not leave spots.



8 How to Replace the Filter



Fig. 1



Fig. 2



Fig. 3



Fig. 4



Fig. 5

Replace your filter when:

- When the filter life indicator number reaches 999 and it is blinking.
- Considering that filter life span can differ based on water quality in individual areas, we recommend replacing the filter before the end of the life span is reached if the water smells or the water flow volume decreases.

Possible situations where filter life can be shortened drastically:

- When you have rusty water due to aged pipes.
- If there is a lot of sediment or impurities in the water for a short period of time.
- If used in a place where the water pressure is very low.

1. Open Both Filter Covers (Fig. 1)

- Press the white button to unlock the cover. It is in the middle of the bottom of the cover.
- With the cover unlocked, lift the cover straight up.

2. Remove Old Filters (Fig. 2)

- Twist the expired filter counterclockwise and lift out.

3. Install New Filters (Fig. 3)

- Remove the protective sticker on the base of each filter. (Bottom as you read the label.)
- Insert the opening in base of the new filter onto the raised filter base.
- Twist clockwise until locked. You should NOT be able to lift it out. If the filter is not fully twisted, it could cause leaking.

4. Reset the Filter Life Indicator (Fig. 4)

- Push the Filter Reset Button (Red on the right and green on the left.)
- You will hear one BEEP when you push it.
- Hold it down until you hear a second BEEP. The filter counter will reset. Release the button.
- Repeat on the other side.

5. Close the cover. (Fig. 5)

- Line up the vertical edges and slide down until you feel/hear the cover lock.

NOTE

Ensure that you install each filter in its proper place: Pre-filter goes in the compartment on the right side; Second-Stage filter goes in the compartment on the left side. This is noted on the filter label.

How to Add Scale Guard or Calcium Inserts

Use scale guard if you have hard water and calcium inserts if you have soft water.

1. Ensure the water flow is off.
2. The inserts go into a port on the top of your filter. To access the filter, follow the instructions in Section 7 - How to Replace The Filter.
3. Once you have the filter removed, unscrew the cap on the top of the filter body. If you have previously used an insert, dispose of the old insert. (Fig 1)
4. The new insert will have a soft silicone protective cap. Remove the cap.
5. Place the new insert into the port on the top of the filter, with the open end up. DO NOT EMPTY THE CONTENTS INTO THE PORT. (Fig. 2)
6. Replace the cap on the port of the filter. Tighten firmly. You will experience leaking water if not tightened properly.
7. Replace the filter following the instructions in the Section 7 - How to Replace The Filter.



Fig. 1



Fig. 2

9 IMPORTANT! Hard Water Information

How to Protect Your Investment and Warranty

Alkaline, ionized water can deliver profound benefits. However, an ionizer can become compromised over time by hard water scale. Hard water scaling essentially "coats" the electrode. A compromised electrode has limited ability to transform the water resulting in decreased performance and benefits. Hard water damage will not only degrade performance, it will void your warranty.

To protect you and your ionizer, read the following information carefully and PLEASE test your water.

Your H2 Series Ionizer includes a hard water test strip.
Test your water BEFORE you install your ionizer



Easy Instructions:

Dip into water sample for 3 seconds. Remove, do not shake.
 Wait 20 seconds and then match with closest color block.
 Colors are stable for 1 minute.

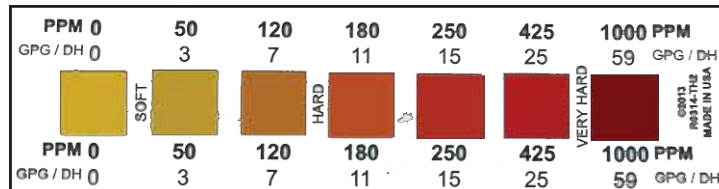

If test strip is this color:	You need to order:
50 ppm or less	Standard Filter
51 ppm to 120 ppm	Scale Guard Insert & Standard Filter
121 ppm to 180 ppm	EOS Scale Guard In-line Filter
181 ppm to 250 ppm	Hard Water Spartan with EOS
251 ppm to 425 ppm	AlkaViva Reverse Osmosis System with Re-mineralizing Filter
Over 426 ppm	Contact AlkaViva Technical Support

FOR ADDED PROTECTION AND PERFORMANCE

You can use our (optional) citric acid Cleaning Filters to help eliminate most mineral scale on the electrodes allowing for longer life and better performance. These can be purchased online from your AlkaViva dealer.

If I have hard water how often do I use a cleaning filter?

If your test strip indicated 50 - 120 ppm use the cleaning filter once every 6 months. -



If your test strip indicated 121 - 250 ppm use the cleaning filter once every 3 months.

If your test strip indicated >251 ppm use the cleaning filter monthly to maintain optimal performance.

See instructions for use on page 21.

Instructions for Using the Cleaning Filter

Cleaning filter will eliminate most mineral scale on the electrodes and inside the chamber of your ionizer allowing for longer life and better performance. It insures that the platinum/titanium plates remain clean and free of scale.

- 
- 
1. Disconnect the electric plug.
 2. Turn off the water supply control valve.

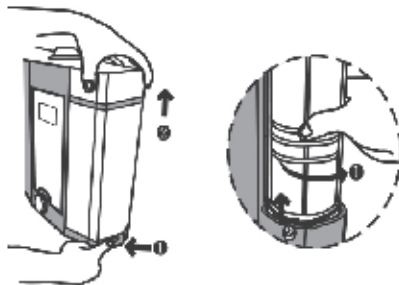

3. Open both filter covers and remove both filters.

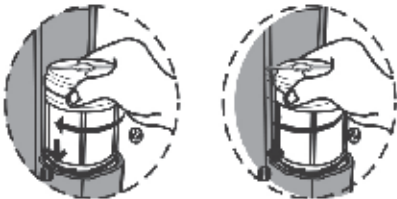

Install empty filter
 on the right side

Install cleaning filter
 on the left side.

4. Install the cleaning filter and the empty filter per above.



Do not use your regular filters with the cleaning filter. Be sure to use the empty cartridge that comes with the cleaning filter.

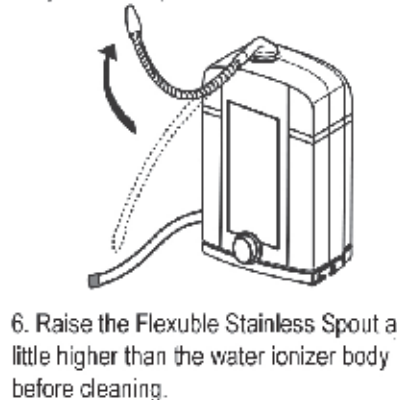
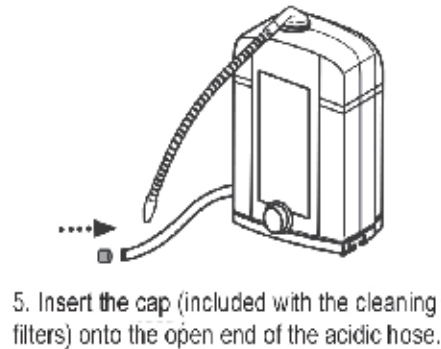

7. Turn on the Flow Control Valve until water drips from the Flexible Stainless Spout. Then turn off the Flow Control Valve and allow the ionizer to sit for 3-5 hours.

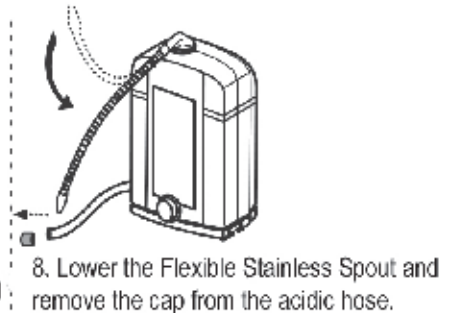

9. Turn on the Flow Control Valve and let water pass freely for about 5-10 minutes.

10. Turn off the Flow Control Valve and replace the cleaning filters with your regular filters. Then let the water run for 2-3 minutes.



11. Close the filter cover and connect the electric power. The cleaning procedure is finished.

For more information about hard water:

<http://www.alkaviva.net/hard-water.php>

<http://www.alkaviva.net/hard-water-treatment.php>

11 Trouble Shooting Guide

Abnormal condition	Cause(s)	Resolution
The Control Panel does not come on.	The power plug is not properly inserted, or it is inserted into a faulty outlet.	Properly insert power plug into a correctly functioning power outlet
	The fuse is blown. The fuse is not inserted properly.	Replace the fuse. A spare fuse is included in your reagent kit. (3A /110 V fuse)
The Control Panel / display indicators do not come on even after turning the tap on.	Faulty PCB (Printed Circuit Board)	Immediately unplug the unit and contact AlkaViva to arrange service.
pH test shows alkaline water color as neutral (7) while acidic water color gets yellow (6).	Faulty or evaporated reagent: alkaline / acidity are always produced in inverse proportion. Therefore, showing an acidic color means inversely that alkaline water has to be generated from the unit. Lack of alkaline color can result from a chemical reaction where carbonic acid in water evaporates some test reagent elements.	Test pH value on level 3 or 4 water; replace reagent.
Power supply is suddenly cut off while operating the unit.	Elevated level of salt in the water or high TDS; extended operation at high pH; sudden flux in electrical current. In these cases your machine will shut down automatically to protect the electrodes and circuitry.	Wait - the unit will become operational again after about 30-60 minutes. Your ionizer has a safety mechanism built-in to protect the electrodes and circuitry. This mechanism will shut the ionizer down automatically. This mechanism protects the unit from overuse or excessive electric current.
Low output of alkaline water from the unit.	Filter is clogged. Premature clogging may be caused by sudden drop in water quality and an influx of sediment or other contaminants, which stress the filter.	Replace your filter. Clean pre-filter
	Low pressure in your household plumbing.	Ensure water supply valves are fully open. The water pressure in house may be too low.
	The input hose is bent, kinked or otherwise restricted.	Straighten the bent hose.

**H₂ SERIES
ALKALINE WATER IONIZER
AND HYDROGEN GENERATOR**

Abnormal condition	Cause(s)	Resolution
Strange smell from Alkaline water.	Expired filter from ordinary use or premature clogging due to flux in water quality.	Replace your filter.
	Sudden flux in water quality with elevated level of some disinfectants and naturally occurring elements in the water (not Chlorine). These elevated levels are observed in some areas during summer months. These levels fall within safe drinking water standards, yet will cause a reaction with ionized water causing a unique smell.	Select lower pH level (1-2). If still present, filter replacement may be necessary.
Water appears milkish; white snow like particles in the bottom of your glass.	<p>You have high hardness (calcium primarily) in your water. The white is extracted CaCO₃ (Calcium carbonate).</p> <p>In water where elevated levels of CO₃ exist, what you see after ionization is CO₂ in the water bonded with Ca.</p>	This is calcium! It is not only harmless, but actually good for you. Remember the ionizer separates and condenses the alkaline minerals and this is what you are seeing. You can lower the setting (1-2) and reduce this effect. Typically this only occurs in hard water areas.
At first no smell, but then smell from the alkaline water about one hour later.	Your water bottle or receptacle is foul and needs cleaning. Contamination mixes with alkaline water when filling your bottle.	Clean your bottle or receptacle. Try selecting lower pH level (1- 2).
	Expired filter.	Replace your filter.
Water leakage from the filter cartridge housing.	Filter not installed correctly into filter housing.	Remove your filter and reinstall it properly following the filter replacement instructions. Increase the quantity of source water inflow.
No acid water flow from the acidic output port.	Acidic output hose is bent, kinked or otherwise restricted.	Straighten the bent hose; increase water flow from supply.

